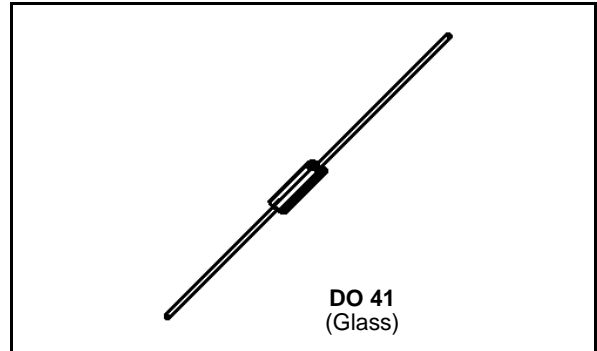

SMALL SIGNAL SCHOTTKY DIODES
DESCRIPTION

Metal to silicon rectifier diodes in glass case featuring very low forward voltage drop and fast recovery time, intended for low voltage switching mode power supply, polarity protection and high frequency circuits.

ABSOLUTE RATINGS (limiting values)

| Symbol | Parameter | | Value | Unit |
|--------------------|--|--|--------------------------------|--|
| $I_{F(AV)}$ | Average Forward Current* | $T_{amb} = 60\text{ }^{\circ}\text{C}$ | 1 | A |
| I_{FSM} | Surge non Repetitive Forward Current | $T_{amb} = 25\text{ }^{\circ}\text{C}$ $t_p = 10\text{ms}$ | 25 Sinusoidal Pulse | A |
| | | $T_{amb} = 25\text{ }^{\circ}\text{C}$ $t_p = 300\mu\text{s}$ | 50 Rectangular Pulse | |
| T_{stg} T_j | Storage and Junction Temperature Range | | - 65 to + 150 - 65 to + 125 | $^{\circ}\text{C}$ $^{\circ}\text{C}$ |
| T_L | Maximum Lead Temperature for Soldering during 10s at 4mm from Case | | 230 | $^{\circ}\text{C}$ |

| Symbol | Parameter | BYV 10-40 | Unit |
|-----------|---------------------------------|-----------|------|
| V_{RRM} | Repetitive Peak Reverse Voltage | 40 | V |

* On infinite heatsink with 4mm lead length

THERMAL RESISTANCE

| Symbol | Test Conditions | Value | Unit |
|---------------|-------------------|-------|----------------------|
| $R_{th(j-a)}$ | Junction-ambient* | 110 | $^{\circ}\text{C/W}$ |

* On infinite heatsink with 4mm lead length

ELECTRICAL CHARACTERISTICS

STATIC CHARACTERISTICS

| Symbol | Test Conditions | | Min. | Typ. | Max. | Unit |
|---------|---------------------------|--------------------------|------|------|------|------|
| I_R^* | $T_j = 25^\circ\text{C}$ | $V_R = V_{RRM}$ | | | 0.5 | mA |
| | $T_j = 100^\circ\text{C}$ | | | | 10 | |
| V_F^* | $I_F = 1\text{A}$ | $T_j = 25^\circ\text{C}$ | | | 0.55 | V |
| | $I_F = 3\text{A}$ | | | | 0.85 | |

* Pulse test: $t_p \leq 300\mu\text{s}$ $\delta < 2\%$.

DYNAMIC CHARACTERISTICS

| Symbol | Test Conditions | | Min. | Typ. | Max. | Unit |
|--------|--------------------------|-----------|------|------|------|------|
| C | $T_j = 25^\circ\text{C}$ | $V_R = 0$ | | 220 | | pF |

Forward current flow in a Schottky rectifier is due to majority carrier conduction. So reverse recovery is not affected by stored charge as in conventional PN junction diodes.

Nevertheless, when the device switches from forward biased condition to reverse blocking state, current is required to charge the depletion capacitance of the diode.

This current depends only of diode capacitance and external circuit impedance. Satisfactory circuit behaviour analysis may be performed assuming that Schottky rectifier consists of an ideal diode in parallel with a variable capacitance equal to the junction capacitance (see fig. 5 page 4/4).

Fig.1 : Forward current versus forward voltage at low level (typical values).

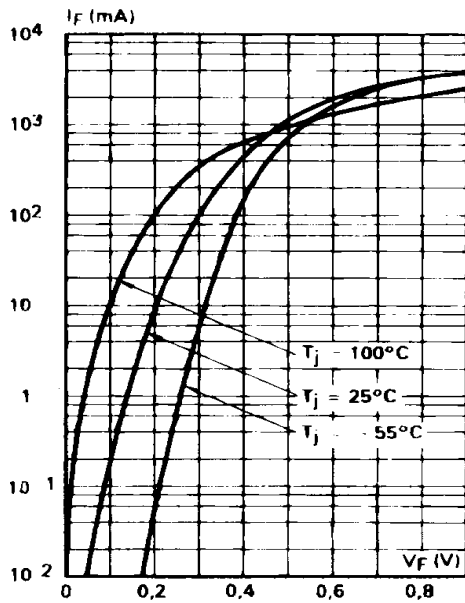

Fig.2 : Forward current versus forward voltage at high level (typical values).

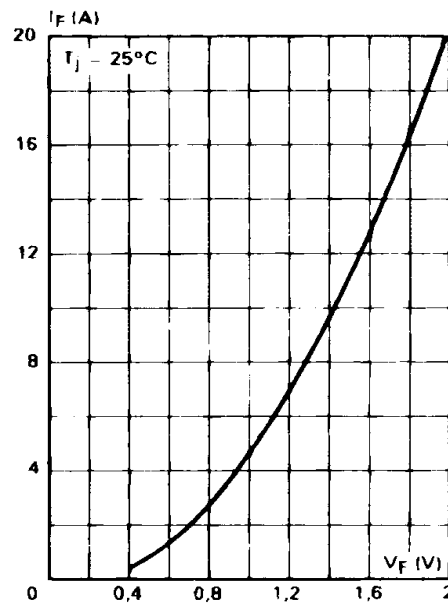

Fig.3 : Reverse current versus junction temperature.

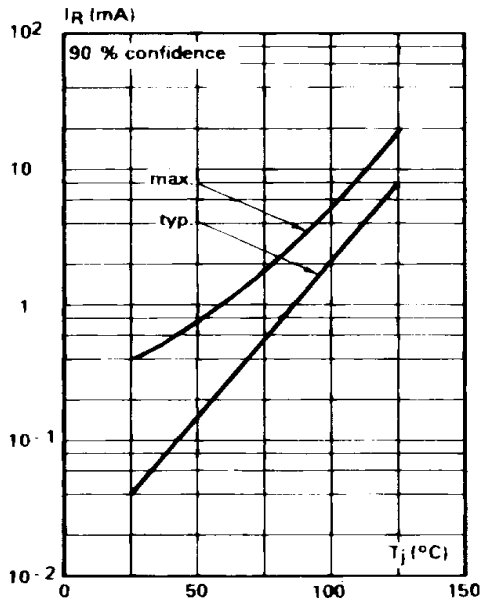

Fig.4 : Reverse current versus V_{RRM} in per cent.

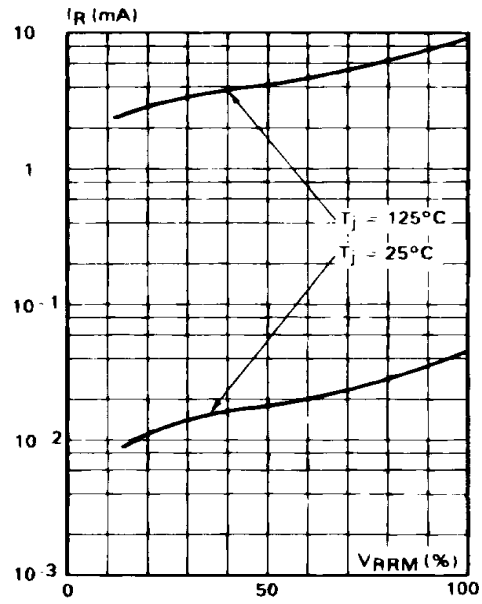

Fig.5 : Capacitance C versus reverse applied voltage V_R (typical values).

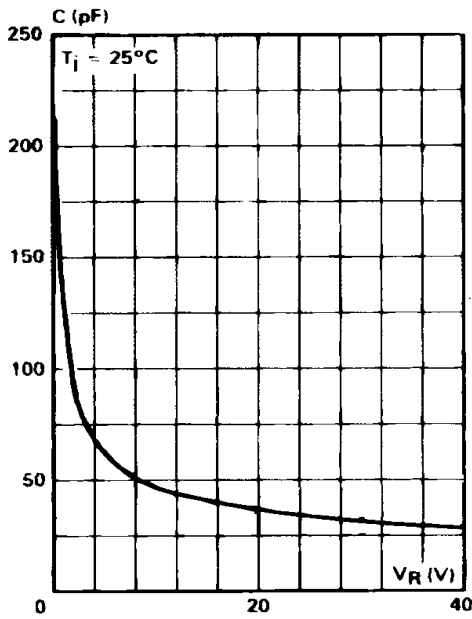

Fig.6 : Surge non repetitive forward current for a rectangular pulse with $t \leq 10$ ms.

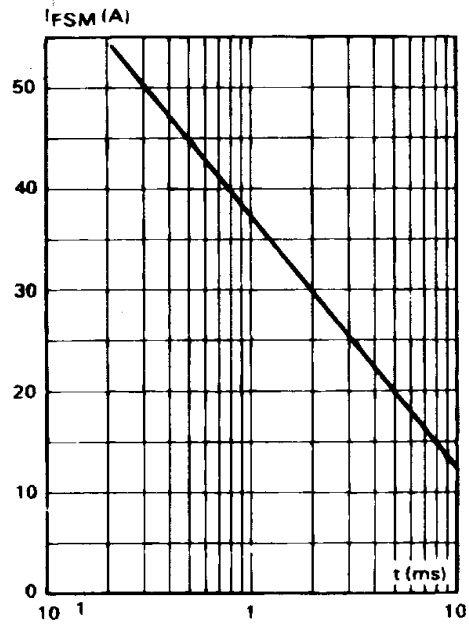
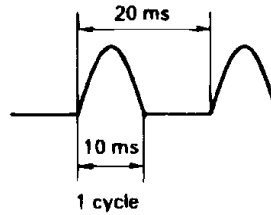
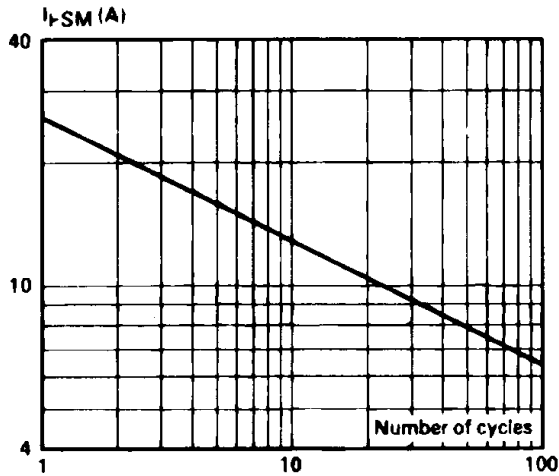
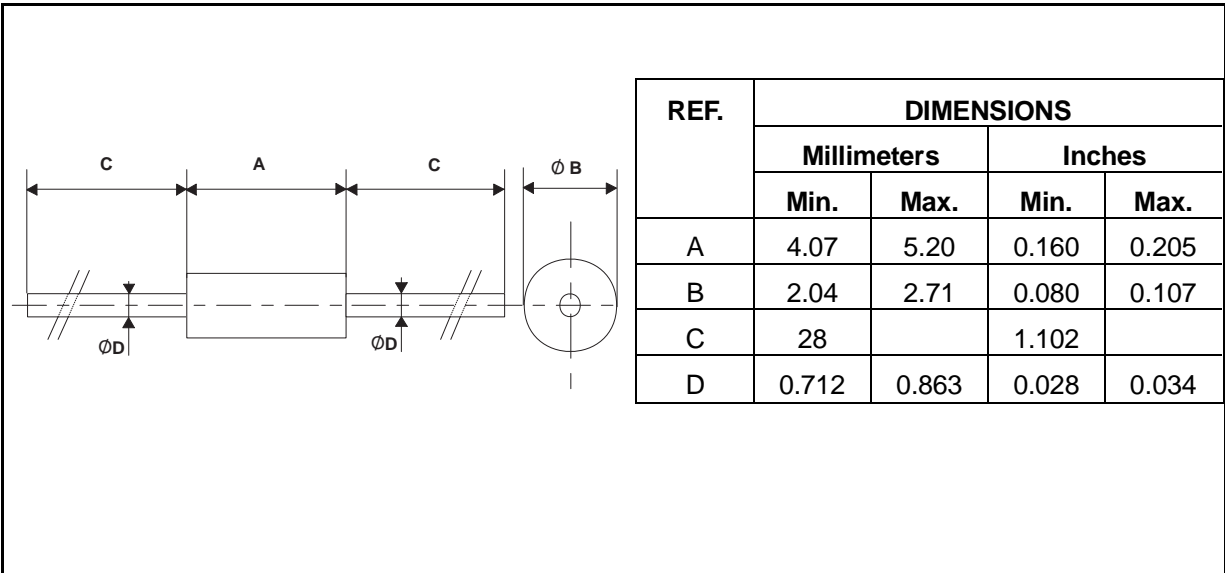

Figure 7. Surge non repetitive forward current versus number of cycles.



PACKAGE MECHANICAL DATA

DO 41 Glass



- **Marking:** clear, ring at cathode end.
- **Cooling method :** by convection and conduction
- **Weight:** 0.33g

Information furnished is believed to be accurate and reliable. However, STMicroelectronics assumes no responsibility for the consequences of use of such information nor for any infringement of patents or other rights of third parties which may result from its use. No license is granted by implication or otherwise under any patent or patent rights of STMicroelectronics. Specifications mentioned in this publication are subject to change without notice. This publication supersedes and replaces all information previously supplied. STMicroelectronics products are not authorized for use as critical components in life support devices or systems without express written approval of STMicroelectronics.

The ST logo is a registered trademark of STMicroelectronics
 © 1998 STMicroelectronics - Printed in Italy - All rights reserved.

STMicroelectronics GROUP OF COMPANIES
 Australia - Brazil - Canada - China - France - Germany - Italy - Japan - Korea - Malaysia - Malta - Mexico - Morocco -
 The Netherlands - Singapore - Spain - Sweden - Switzerland - Taiwan - Thailand - United Kingdom - U.S.A.

